

Standard Series

SS8x6-003345

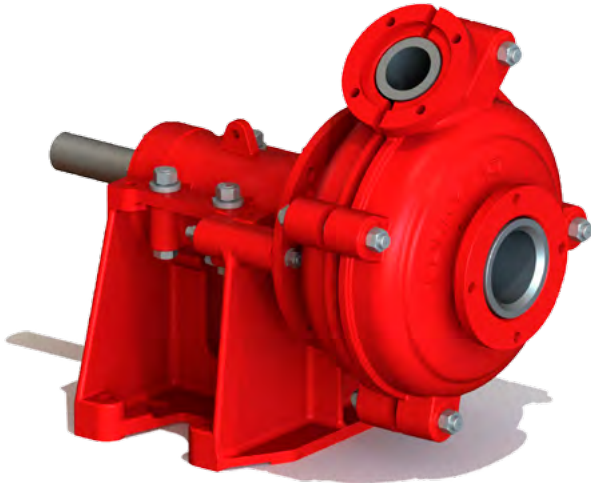

Suction	203 mm (8")
Discharge	152 mm (6")
Maximum RPM	1300
Sealing system	Standard gland packing
Impeller material	High chrome
Liner material	High chrome
Throat bush	High chrome
Maximum motor power	260 kW
Weight-Bare shaft pump	1814 kg

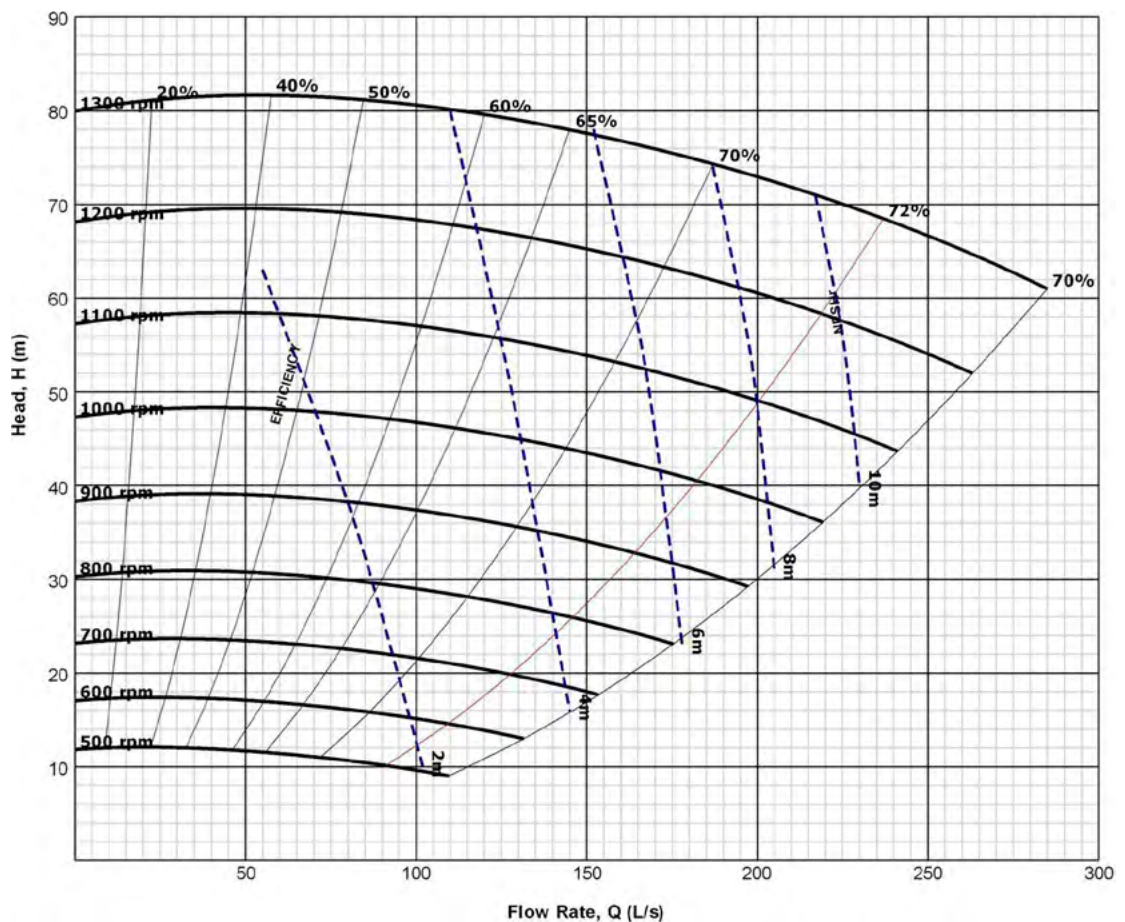

NOTE This information is for guidance/reference only. For application specific drawings and curves, please contact your nearest authorised distributor at slurrypro.com

Standard Series

SS8x6-003345

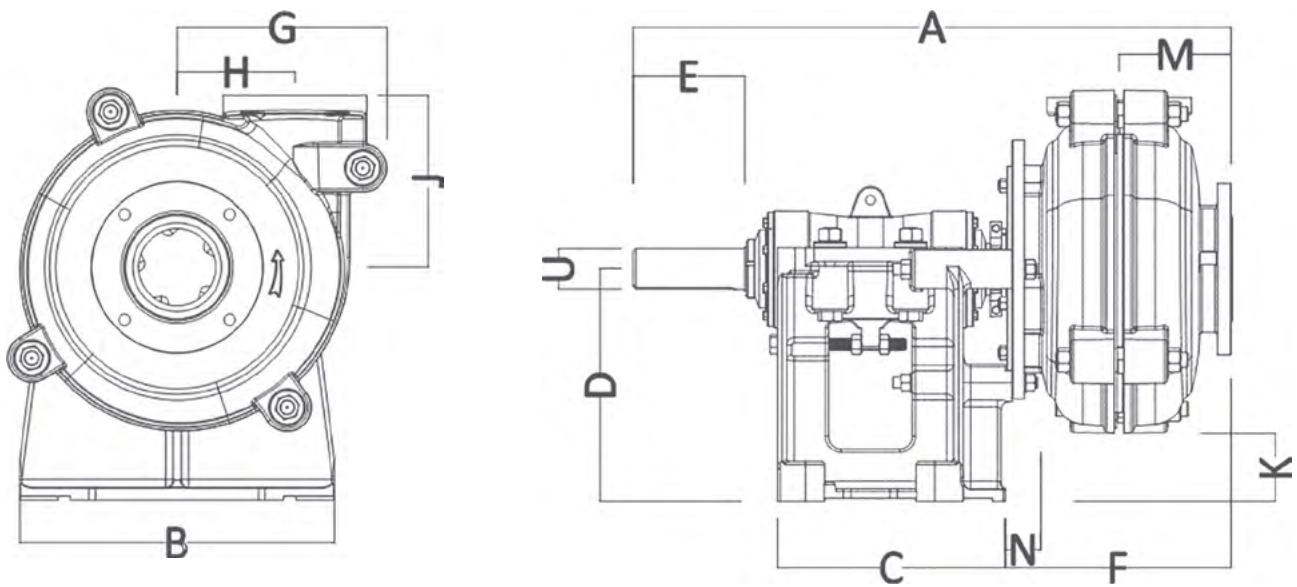

A	B	C	D	E	F	G	H
1507	857	635	610	279	539	551	318
J	K	L	M	N	U	Key size	
460	90	0	292	65	100	28 x 16	

All values in millimetres (mm)