

Standard Series SS10x8-001145

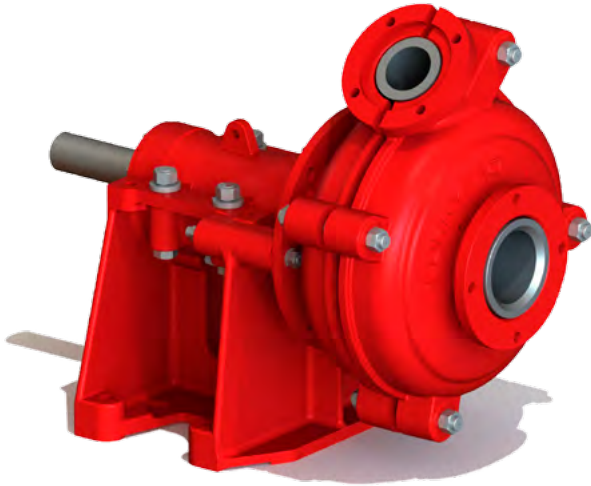

Suction	254 mm (10")
Discharge	203 mm (8")
Maximum RPM	750
Sealing system	Standard gland packing
Impeller material	Rubber
Liner material	Rubber
Throat bush	Rubber
Maximum motor power	260 kW
Weight-Bare shaft pump	3129 kg

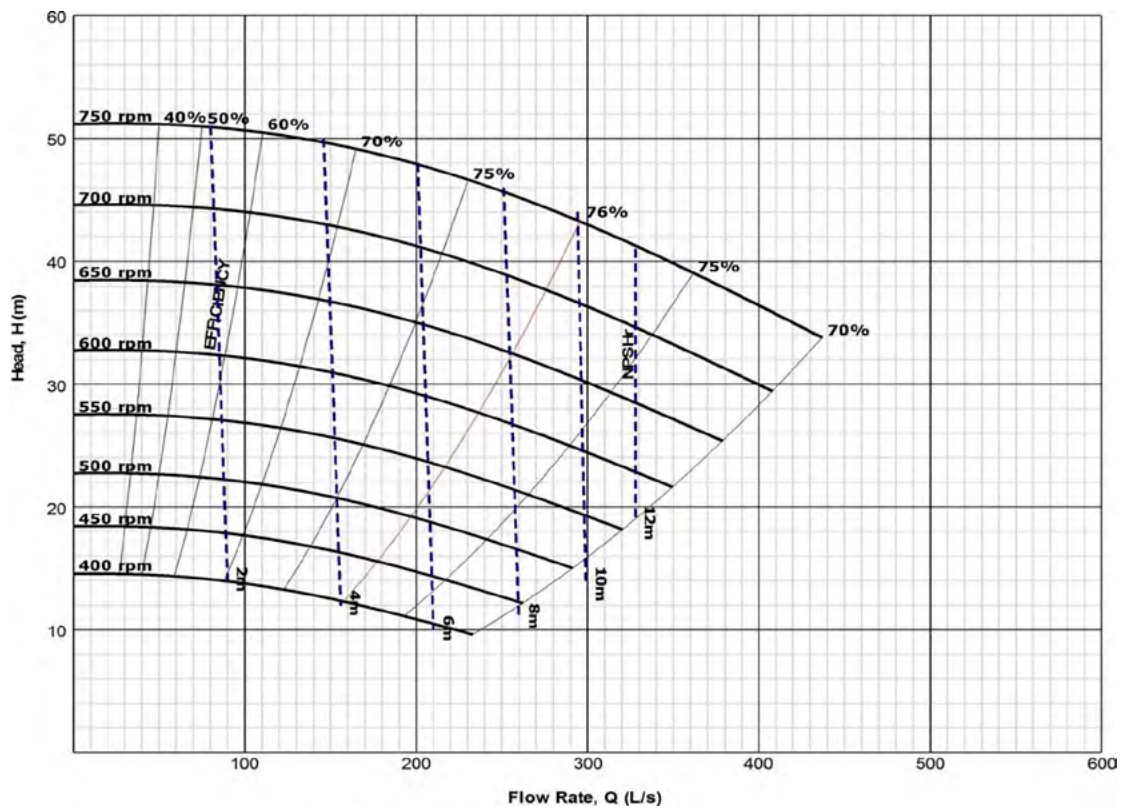

NOTE This information is for guidance/reference only. For application specific drawings and curves, please contact your nearest authorised distributor at slurrypro.com

Standard Series

SS10x8-001145

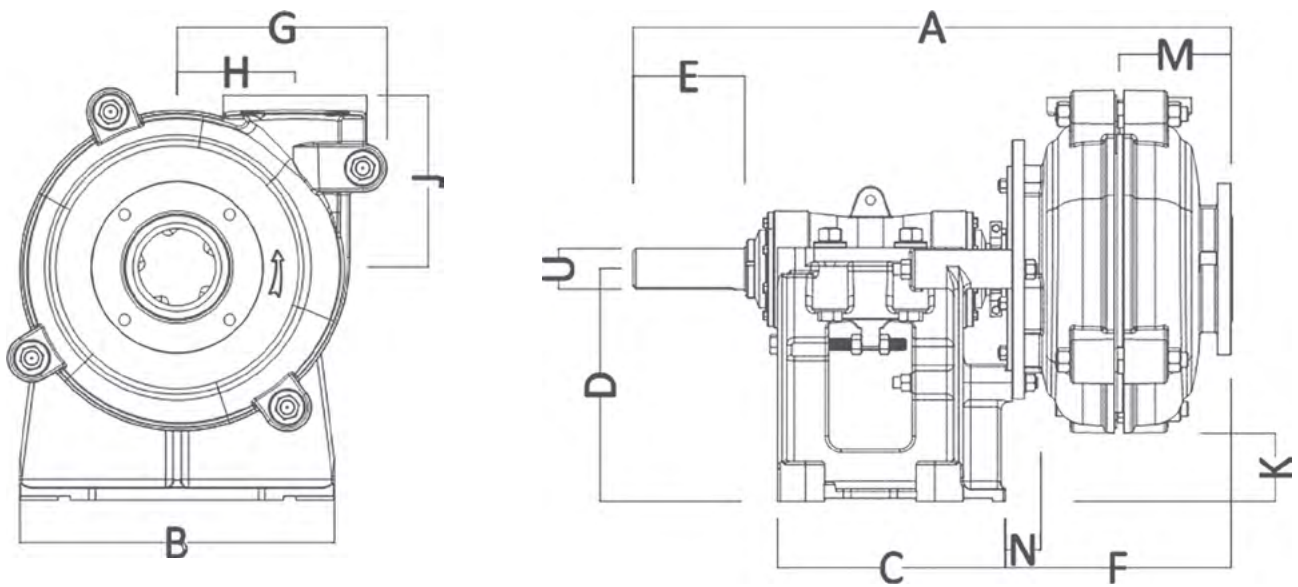

A	B	C	D	E	F	G	H
1645.92	991.11	705.1	610.11	278.89	683.01	673.1	419.1
J	K	L	M	N	U	Key size	
635	0	11.94	332.99	134.11	100	28 x 16	

All values in millimetres (mm)