

Standard Series SS10x8-000045

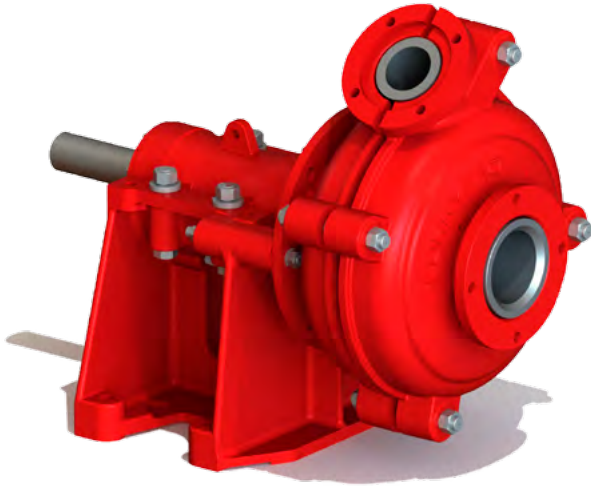

Suction	254 mm (10")
Discharge	203 mm (8")
Maximum RPM	1000
Sealing system	Standard gland packing
Impeller material	High chrome
Liner material	High chrome
Throat bush	High chrome
Maximum motor power	260 kW
Weight-Bare shaft pump	3742 kg

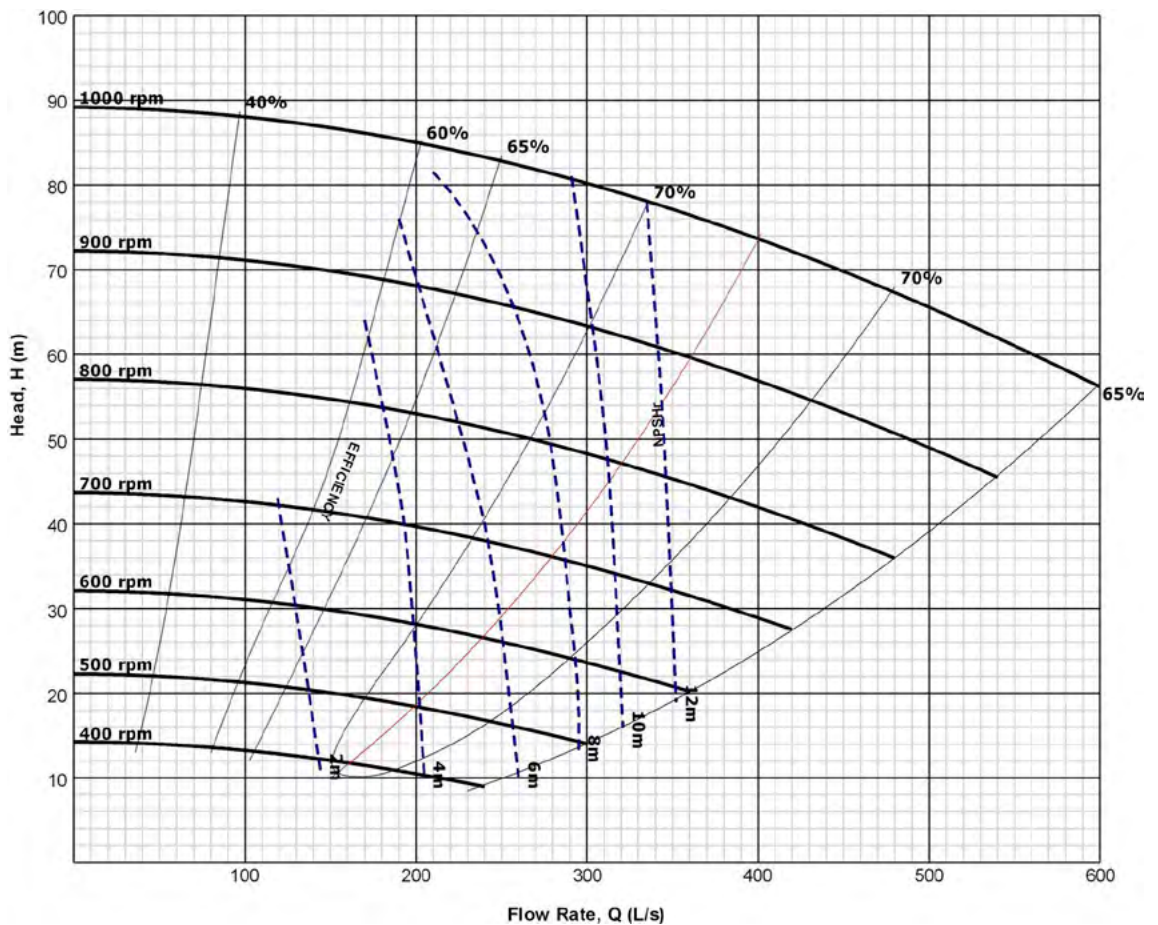

NOTE This information is for guidance/reference only. For application specific drawings and curves, please contact your nearest authorised distributor at slurrypro.com

Standard Series

SS10x8-000045

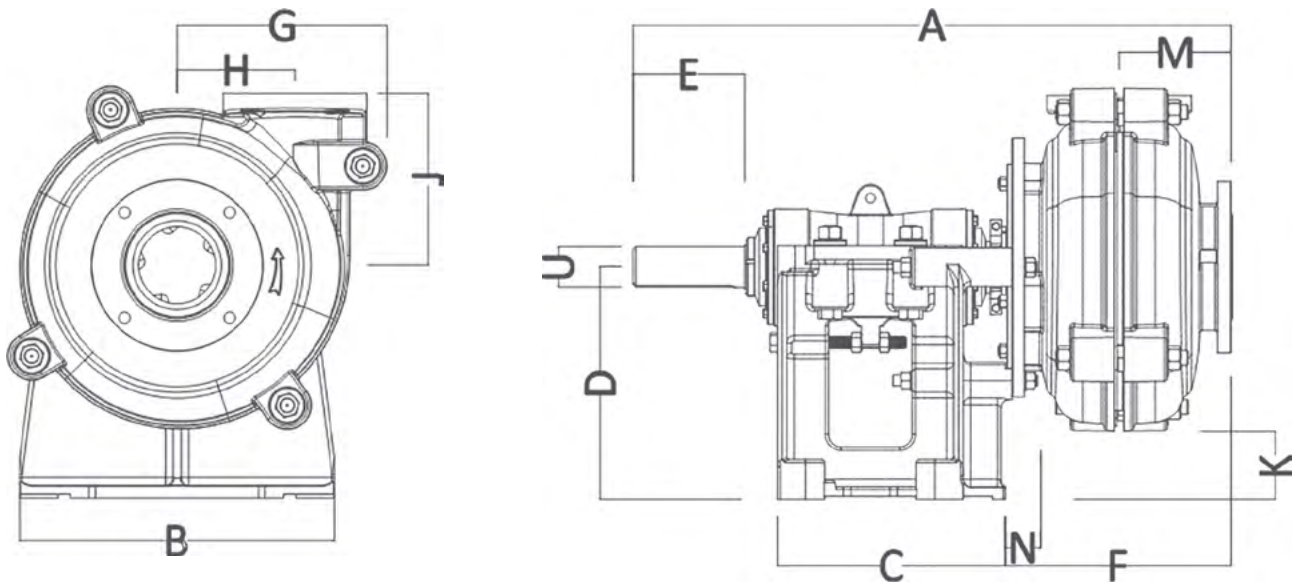

A	B	C	D	E	F	G	H
1645.92	991.11	705.1	610.11	278.89	683.01	673.1	419.1

J	K	L	M	N	U	Key size
635	0	11.94	332.99	134.11	100	28 x 16

All values in millimetres (mm)